

KANSA

SOLAR BOLLARD



Designed in aluminum and treated to withstand the harshest conditions, the Solux solar bollards will be perfect for all your lighting, marking, and beautification applications for your outdoor living spaces with total energy autonomy. Equipped with high-efficiency solar cells, the light fixture charges in the sun but also in cloudy weather, ensuring **optimal lighting throughout the year**.

NOMINAL FLUX **480 LUMENS**
NOMINAL POWER **4 WATTS**

LIGHTING

Efficiency **120 Lumens/Watts**
Chips LED **PHILIPS Luxeon 30-30**
LED lifetime **Over 80 000 hours LM80**
Optics/CCT **T-V / 2300K to 6500K (Dual CCT optional)**
Light Height **100 cm**

BATTERY

Technology **Lithium Iron Phosphate LIFEPO4**
Capacity **38Wh**
Autonomy **Over 24 hours at full charge - 4 Rainy Days back up**
Charging time **6 hours**
Lifespan **Over 3000 CYCLES @ 80% DOD over 10 years Lifetime**
Working temp **.14 °F to 158 °F (optional - 40 °F to 158 °F) -10°C to 70 °C - (optional -40°C To 70°C)**

Solar panel **10 Wc**
Cells type **Monocrystalline Panel Grade A 25 years**
Certificates **IEC 61215 - IEC 61730 I and II - IEC 60904**

ELECTRONIC

Sensor **PIR 180° sensor (optional)**

DIMENSIONS

Product **D 15,75" x H 39,37" (D 40cm x H 100 cm)**
Carton size **41,73" x 17,72" x 18,11" (106 cm x 45 cm x 46 cm)**
Weight **20,50 lb (9.3 KG)**
Materials **Die cast aluminum**
Installation **Concrete base or insert on support**
Product code **SL-005**

Solux retains the right to modify or change product specifications without prior notice, as part of our ongoing commitment to improvement



CERTIFICATIONS

IEC / TUV / EMC / LM-79- 08 and LM-80 test standards / IK8 / IP65 / CE / ULOR

**5
YEARS**

*** Solux offers a 5 Year Limited Warranty** for the Solar Bollard-Series luminaire to be free from defects in material and workmanship for up to five (5) years from date of shipment. This limited warranty covers all components when installed and operated according to Solux instructions. Fixture suitable for ambient temperature from -10° to 50°. PV Panels - 20 year performance warranty Controller & Batteries : 5 years

KANSA - SOLAR BOLLARD - DATA SHEET / Page 1 of 5

sales@gordonbullard.com
www.bullardbollards.com
1-877-964-4646



991 South Gull Lake Dr
Richland, MI 49083
USA

LUMINAIRE & LEDS

The **KANSA** bollard incorporates the latest LED technologies, its elegance and ease of installation will meet your lighting needs.

KANSA is equipped with **LED chips, combining performance and robustness with 120 lumens per watt.**

A TOTAL OF 480 LUMENS

Our light fixture also complies with current standards concerning light pollution.



SYMMETRICAL DISTRIBUTION

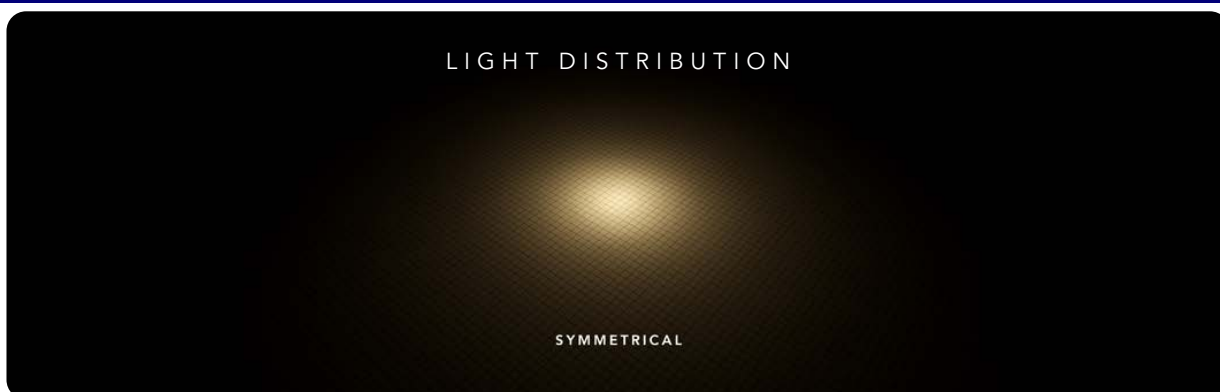

PHOTOMETRIC CURVE

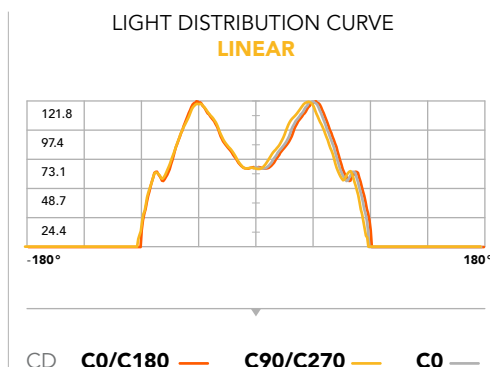
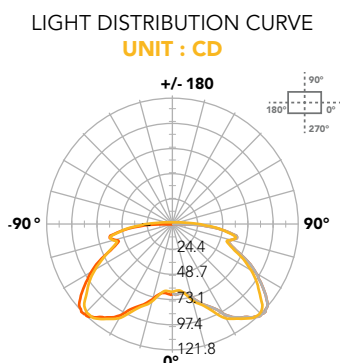

[DOWNLOAD IES FILES](#)



KANSA - SOLAR BOLLARD - DATA SHEET / Page 2 of 5

sales@gordonbullard.com
www.bullardbollards.com
1-877-964-4646



991 South Gull Lake Dr
Richland, MI 49083
USA

BATTERY LIFEPO4

OVER 10 YEARS LIFESPAN

The **KANSA** bollard is equipped with Lithium Iron Phosphate LIFEPO4 batteries, recognized as the **best battery technology** in terms of **longevity, safety, and performance** for solar applications. Our batteries enjoy a lifespan of over **3000 cycles**, which is more than **10 years at 80% DOD**.



EXTREME TEMPERATURE

**14°F to 158°
- 10 °C TO 70 °C**

While standard batteries benefit from an operating temperature of -10°C to 70°C, **Solux offers as optional a new Special LIFEPO4 battery with working range of 40°F to 158°F -40°C to 70°C.**

BMS ELECTRONIC PROTECTION BATTERY MANAGEMENT SYSTEM

Our batteries are equipped with **electronic circuit boards** for a higher **protection**, ensuring battery functioning optimization in any situation.

THE BMS PROTECTS AGAINST

**OVER/UNDER CURRENT • OVERLOAD • OVER/UNDER VOLTAGE
• OVER/UNDER CHARGE • TEMPERATURE MANAGEMENT**

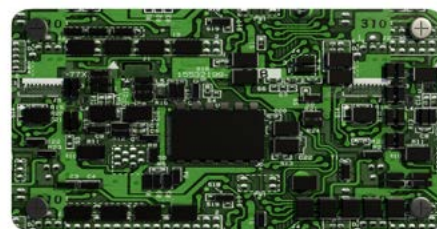

COMPARISONS OF DIFFERENT BATTERY TECHNOLOGIES

LIFETIME & CYCLES AT 80% DOD*
Comparison of different battery technologies



Lead Acid
200



NimH
700



Lithium ION
800



Lithium LifePO4
3 000

**CHARGING TEMPERATURE RANGE
WITHOUT CAPACITY LOSS**
*Minimum & Maximum temperature range for
Optimal charging during the day*

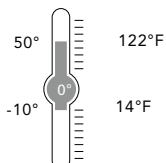

Lead Acid

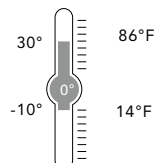

NimH

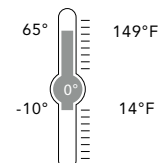

Lithium ION

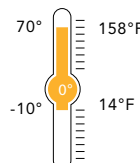

Lithium LifePO4

KANSA - SOLAR BOLLARD - DATA SHEET / Page 3 of 5

sales@gordonbullard.com

www.bullardbollards.com

1-877-964-4646



991 South Gull Lake Dr

Richland, MI 49083

USA



SOLAR PANEL

Solar cells **GRADE A**

10 WATTS

Encapsulated Monocrystalline Solar Panel **Grade A** Solar Cell with Tempered Glass.

OUR PV PERFORMANCE GUARANTEE

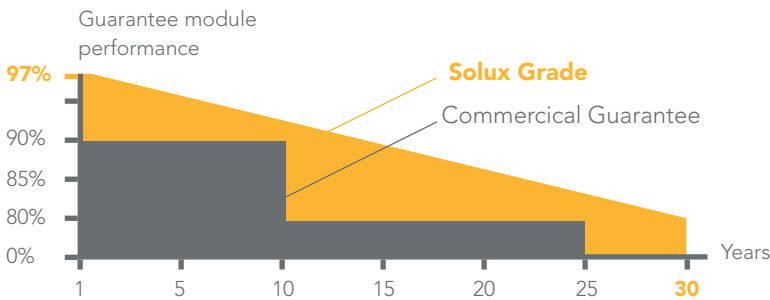

PRESENCE DETECTOR INFRA-RED SENSOR

THE KANSA BOLLARD AUTOMATICALLY TURNS ON AT DUSK AND OFF AT DAWN.

Solux offers optional PIR movement sensor. The infra red detector integrated into the light fixture will increase the light power as pedestrians or vehicles pass, thus providing a higher level of safety while respecting the environment.

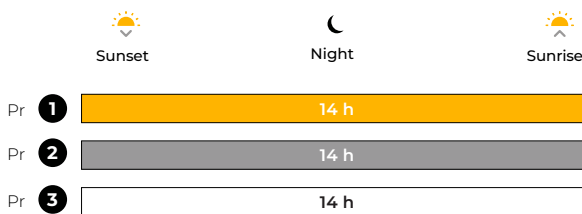
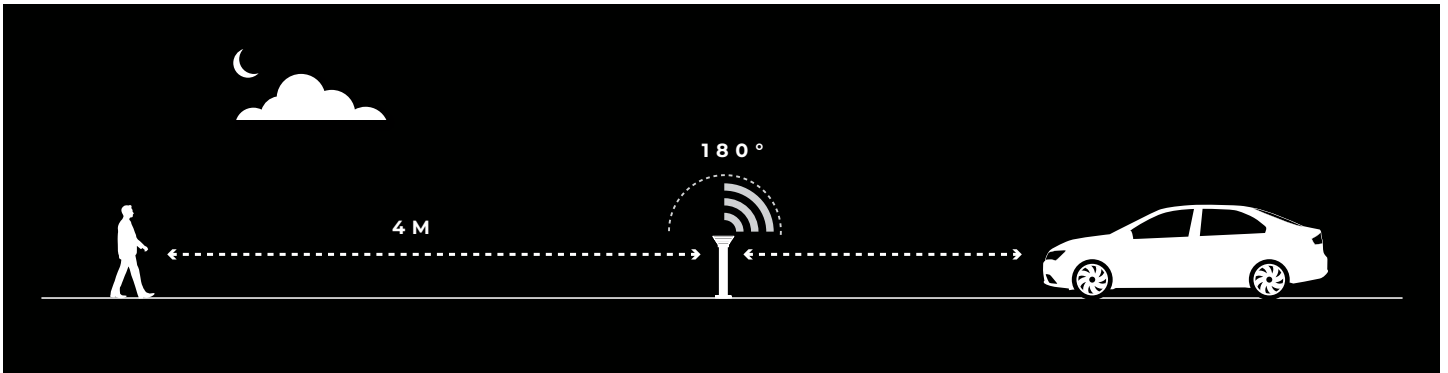

Depending on the geographical area, we will select the % of light reduction.

- Program 1** > 40% Dim + 100% ON during 20 sec
- Program 2** > 30% Dim + 100% ON during 20 sec
- Program 3** > 20% Dim + 100% ON during 20 sec





EASY INSTALLATION

NO CABLING • NO TRENCHING

No wiring or trenching is necessary, you just need to embed the KANSA in concrete or on anchor rods.

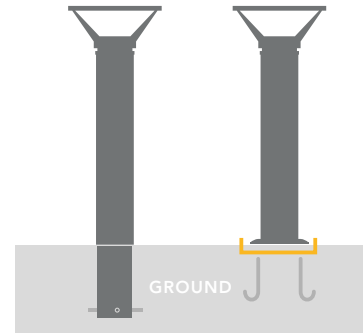

1 DIRECT BURIED **2** FLAT MOUNT

DIMENSIONS

BOLLARD AND BASE

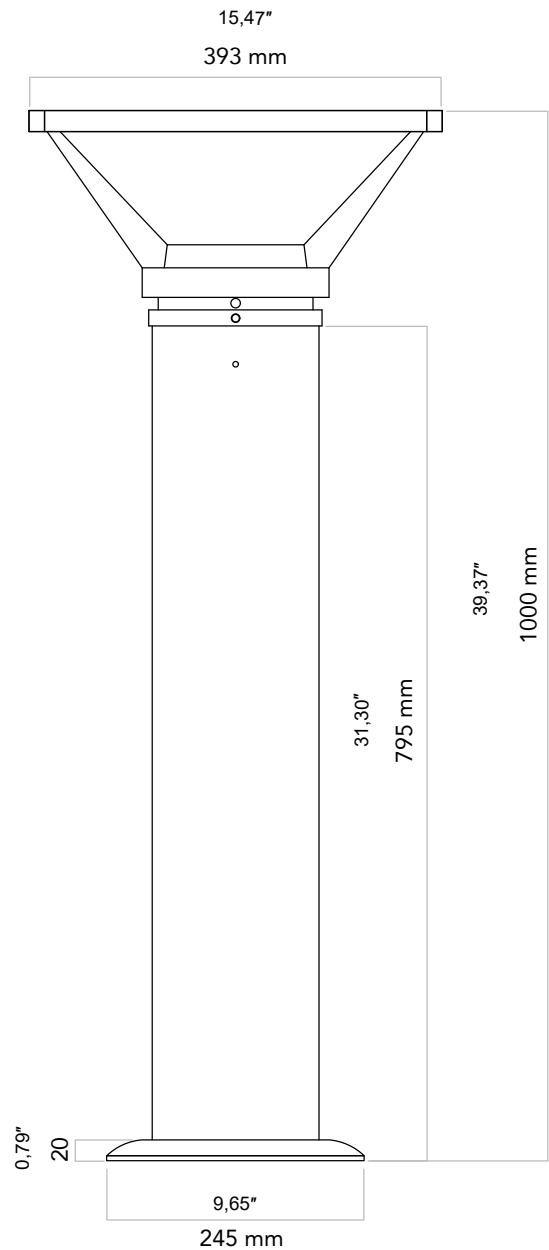
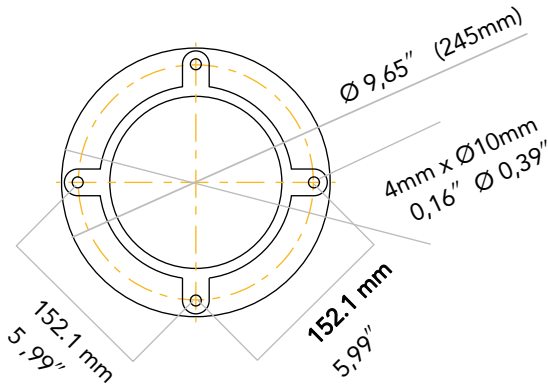

*All dimensions are in mm

