

SSLX PERFORMANCE 120 SOLAR STREET LIGHT SPLIT

Product code: S X - 1 2 0

Based in same design as the SSLXPRO, the **SSLX PERFORMANCE** maintains all of the same quality technology and components while offering a simpler design with the purpose of offering a more affordable solution without compromise on durability and performance

NOMINAL FLUX **23 520 LUMENS**
NOMINAL POWER **120 WATTS**

LIGHTING

Efficiency **196 Lumens/Watts**
Chips LED **PHILIPS Luxeon 30-30**
LED lifetime **Over 80 000 hours LM80**
Optics/CCT **TII-S / T3-M/ T-V -- 2300 to 6500K**
Light Height..... **From 8 to 10 Meters (From 314,96" to 393,70")**

BATTERY

Technology..... **Lithium Iron Phosphate LIFEPO4**
Capacity **1536 Wh**
Autonomy **Over 24 hours at full charge - 4 Rainy Days back up**
Charging time **5-6 hours**
Lifespan..... **Over 3000 CYCLES @ 80% DOD over 10 years Lifetime**
Working temp..... **14°F to 158°F (optional - 40°F to 158°F) -10°C to 70 °C - (optional -40°C To 70°C)**

ENERGY

Solar panel **250 Watts /18V**
Cells type..... **Monocrystalline Panel Grade A 25 years**
Certificates **IEC 61215 - IEC 61730 I and II - IEC 60904**

ELECTRONIC

Controller..... **MPPT SMART CONTROLLER (SOLUX BRIDGE optional)**
Sensor..... **Microwave 360° Motion Sensor**
Cabling **Waterproof Connector, Plug and Play**
Protection **Battery Management System (BMS)**

MECHANICAL

Pole mounting..... **89mm - 76mm (3,50" x 3,00")**
Material **Aluminium and Stainless Steel**

DIMENSIONS

Product..... **1260mm x 880mm x 271mm (49,61" x 34,65" x 10,67")**
Carton size **1320mm x 945mm x 245mm (51,97" x 37,21" x 9,65")**
Net Weight..... **25 KG (55,12 lb)**
Gross Weight **30 KG (66,14 lb)**
QTY /CTN 20"/40"..... **81/162**

How to order?

Product code - CCT - Finish Option
For Example: SX-120-2300K-Black

Solux retains the right to modify or change product specifications without prior notice, as part of our ongoing commitment to improvement



Hiking
Trails



Car Parks &
Rest Areas



Main
Roads



Secondary
Roads

CERTIFICATIONS

IEC / TUV / EMC / LM-79- 08 and LM-80 test standards / IK8 / IP65 / CE / ULOR



*** Solux offers a 5 Year Limited Warranty** for the SSLX Performance luminaire shall be free from defects in material and workmanship for up to five (5) years from date of shipment. This limited warranty covers all components when installed and operated according to Solux instructions. Fixture suitable for ambient temperature from -10° to 50°. PV Panels - 20 year performance warranty Controller & Batteries : 5 years

SSLX PERFORMANCE 120 - STREET AND AREA LIGHTING - DATA SHEET / Page 1 of 6

sales@gordonbullard.com

www.bullardbollards.com

1-877-964-4646



991 South Gull Lake Dr

Richland, MI 49083

USA

LUMINAIRE HOUSING & LEDS

23 520 LUMENS - 2300 TO 6500 K

Extruded low-copper aluminum. **Protection class** (IP65). Solux uses a high quality Polyester Powder Coating from **AKZO NOBEL**. This powder coating provides an excellent salt and humidity resistance as well as ultra violet resistance for color retention for this product. Our Luminaire is equipped with **PHILIPS LUXEON HE PLUS** High efficiency Chips offering and overall **196 Lumens per Watt efficiency**. Our luminaire also complies with the **DARK SKY** requirement for light pollution with an **Upward lighting of 0.31%**.



IP65



▶ LED	3030	LED QTY (PCS)	72	LENS (PCS)	35	CRI	> 80
-------	------	---------------	----	------------	----	-----	------

DIFFERENT OPTICS*

Our different optics will allow you to optimize the lighting results of your projects



*Please contact us for more optics.

LIGHT DISTRIBUTION CURVES

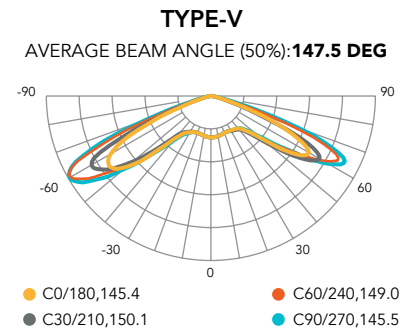
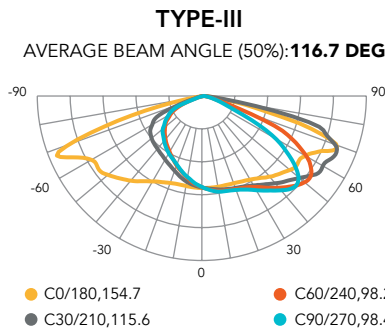
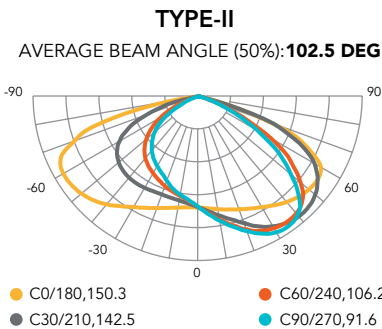

SELECTION Type-II TYPE-III TYPE-V



BATTERY LIFEPO4

+ OVER 10 YEARS LIFETIME

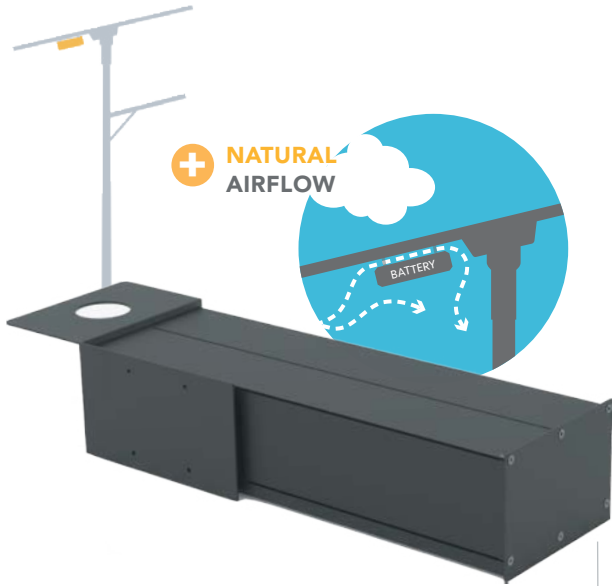

ALUMINUM WATERPROOF CASING & NATURAL AIRFLOW

High temperatures greatly negatively affect the battery's lifespan. This is why our batteries are **encapsulated in an aluminum waterproof casing** for a perfect heat dissipation.

In addition to that, the casing enjoys a natural airflow which **keeps the battery to ambient temperature.**

The SSLX Performance Series is equipped with **Iron Phosphate Lithium LiFePo4** battery. This technology is proved to be **the best chemical technology for solar application on the market.**

With a cycle life of **over 3000 Cycles @ 80% DOD**, the battery enjoys lifespan of over 10 years.

EXTREME TEMPERATURE

**14°F to 158°F (-40 °F OPTIONAL)
-10 °C TO 70 °C (-40 °C OPTIONAL)**

When Standard Lithium LiFePo4 batteries enjoy a working temperature range from 14°F to 158°F (-10°C TO 70 °C). Solux offers as optional a new Special LIFEPO4 battery with working range of -40°F to 158°F (-40 °C. to 70 °C).

EASY MAINTENANCE & ANTI THEFT SCREWS

Easy and direct access to the battery casing for maintenance. The fixation are made with anti theft screws, which request special tooling to unscrew.

BMS ELECTRONIC PROTECTION BATTERY MANAGEMENT SYSTEM

Our batteries are equipped with **electronic circuit boards for a higher protection**, ensuring battery functioning optimization no matter the situation.

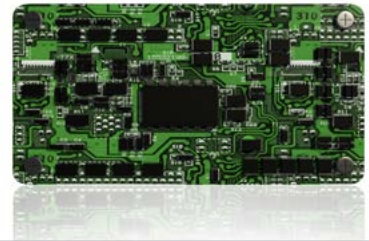

The BMS Protects against :

- OVER/UNDER CURRENT • OVERLOAD • OVER/UNDER VOLTAGE • OVER/UNDER CHARGE • TEMPERATURE MANAGEMENT

COMPARISONS OF DIFFERENT BATTERY TECHNOLOGIES

LIFETIME & CYCLES AT 80% DOD*

Comparison of different battery technologies



Lead Acid
200



NimH
700



Lithium ION
800



Lithium LifePO4
3 000

CHARGING TEMPERATURE RANGE WITHOUT CAPACITY LOSS

Minimum & Maximum temperature range for Optimal charging during the day

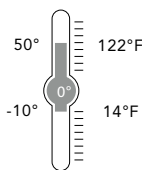

Lead Acid

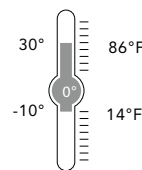

NimH

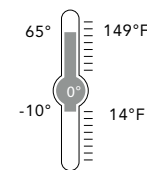

Lithium ION

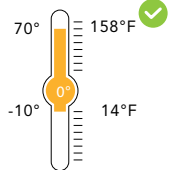

Lithium LifePO4

SOLAR PANEL

solar cells
GRADE A

250 WATTS

High efficiency mono-crystalline **Solar panels**. Carefully selected **Grade A** Solar cells. Up to 20.4% efficiency, all protected by self-cleaning **tempered glass at 30 degrees** of inclination.

Its **anodized** aluminium alloy frame gives it a modern and elegant design as well as perfect resistance to corrosion. They are also equipped with fully **waterproof Plug and Play connectors**.

OUR PV PERFORMANCE GUARANTEE

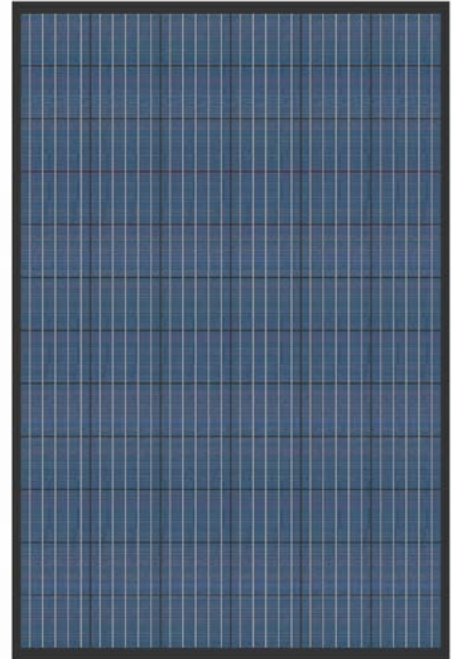
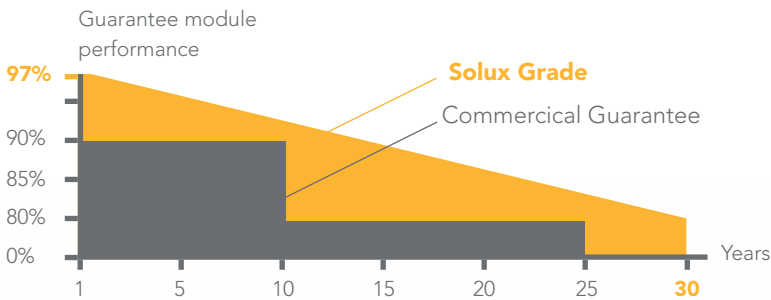

CONTROLLER MPPT

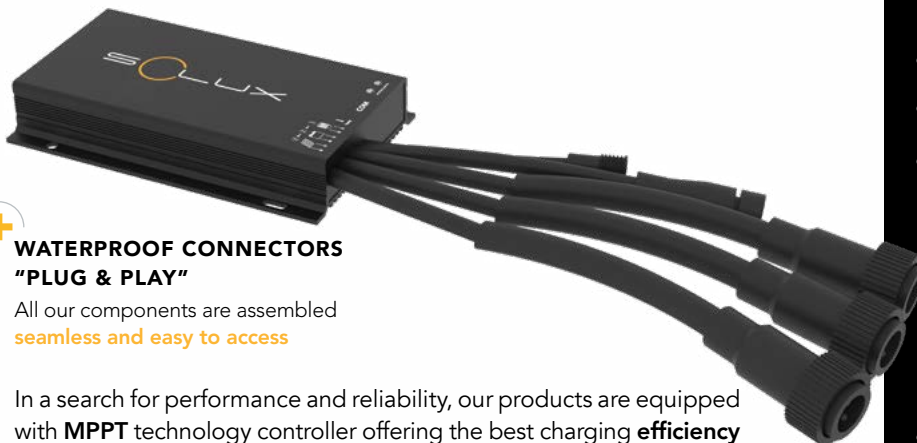

+ WATERPROOF CONNECTORS "PLUG & PLAY"

All our components are assembled **seamless and easy to access**

In a search for performance and reliability, our products are equipped with **MPPT** technology controller offering the best charging **efficiency on the market up to 98%**

REMOTE CONTROL MONITORING

In order to facilitate all maintenance operations and above all to diagnose any possible problem, without having to intervene mechanically on the luminaire, **Solux luminaires are equipped with a wireless diagnostic system via remote control**



With a simple click it is possible to have real-time information such as:

- Automatic diagnosis in case of malfunction
- State of charge and battery history
- Real Time load and solar panel energy production history
- Age of the product and installation
- Temperature and its history

F E A T U R E S

- Minimal stand-by power consumption
- Current consumption $\leq 10\text{mA}$
- Intelligent battery management
3 Phases charging :
 - **Charge MPPT**
 - **Constant voltage**
 - **Floating voltage**

- **Intelligent LED driver** Auto detecting of Dusk and Dawn for automatic operation, 7 Lighting Programs Configuration.

- **ANTI BLACK OUT** : Load adjust according to battery capacity assuring **all night long lighting in any weather conditions.**

- The controller also acts against:
 - **OVERLOAD**
 - **OVERCURRENT**
 - **OVERTEMPERATURE**
 - **OVERVOLTAGE / OVERLOAD**
 - **OVERDISCHARGE**

SSLX PERFORMANCE 120 - STREET AND AREA LIGHTING - DATA SHEET / Page 4 of 6

sales@gordonbullard.com
www.bullardbollards.com
1-877-964-4646



991 South Gull Lake Dr
Richland, MI 49083
USA

MOTION SENSOR MICROWAVE

Solux luminaires are equipped with microwave sensors that use the **Doppler effect** (like car radars) to detect a nearby objects and measure the distance. The sensor emits a high frequency wave to reflect off of and analyze the objects in the vicinity.

Since the microwaves **only detect specific objects**, detection reliability increases resulting in :

- Much better reliability compared to the Infrared sensor
- Up to **360°** Directivity
- Insensitivity to **other environmental variations** such as light, color, temperature, etc.

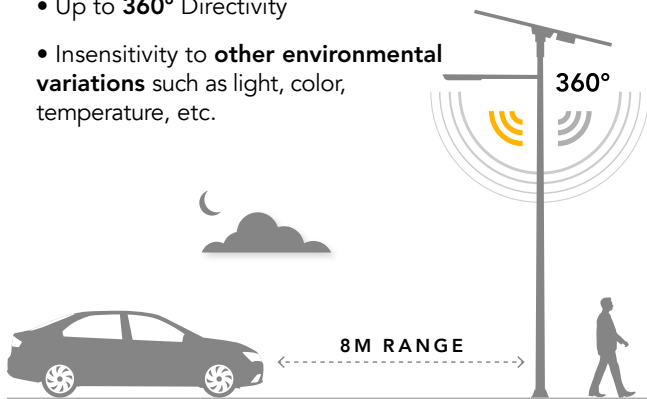

OPERATION MODE & LIGHTING SCHEDULE

In addition to automatic switching on and off , you have the possibility of choosing among **different modular operating modes** according to the needs of the project

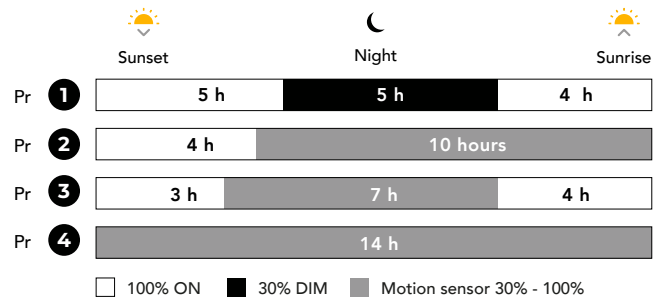

CONTACT US FOR MORE PROGRAM OPTIONS

SOLUX BRIDGE REMOTE MONITORING

As part of his continuous effort for development, the solux team is proud to have developed a special tool for **remote monitoring** of our solar street light. **Solux Bridge** uses low frequency technology LORA or ZIGBEE to **monitor in real time a batch of solar street lights**.

YOU CAN NOW **MANAGE YOUR SOLAR PARK REMOTELY:**

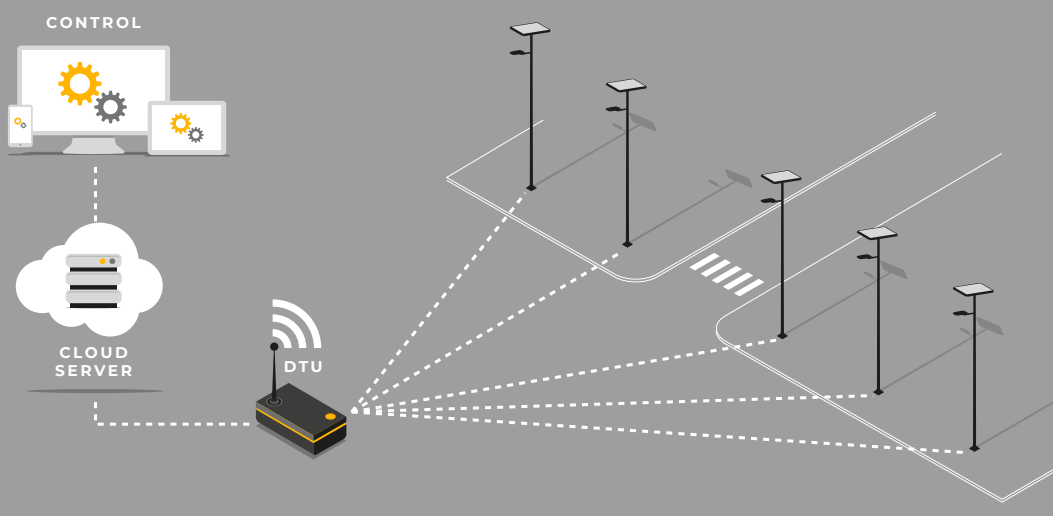

- INTERNET 2G/3G/4G
- CONNECTION SECURE
- GREAT RANGE OF COMMUNICATION
- LOW CONSUMPTION

SSLX PERFORMANCE 120 - STREET AND AREA LIGHTING - DATA SHEET / Page 5 of 6

sales@gordonbullard.com
www.bullardbollards.com
1-877-964-4646



991 South Gull Lake Dr
Richland, MI 49083
USA

EASY INSTALLATION

NO CABLING
NO TRENCHING

With a well designed bracket support, SSLX Performance is effortless and flexible to install. Free 360° rotation of the panel to always face the Sun

INSERT, ORIENTATE & CHOOSE YOUR TILT



DIMENSIONS*

SOLAR PANEL & LED

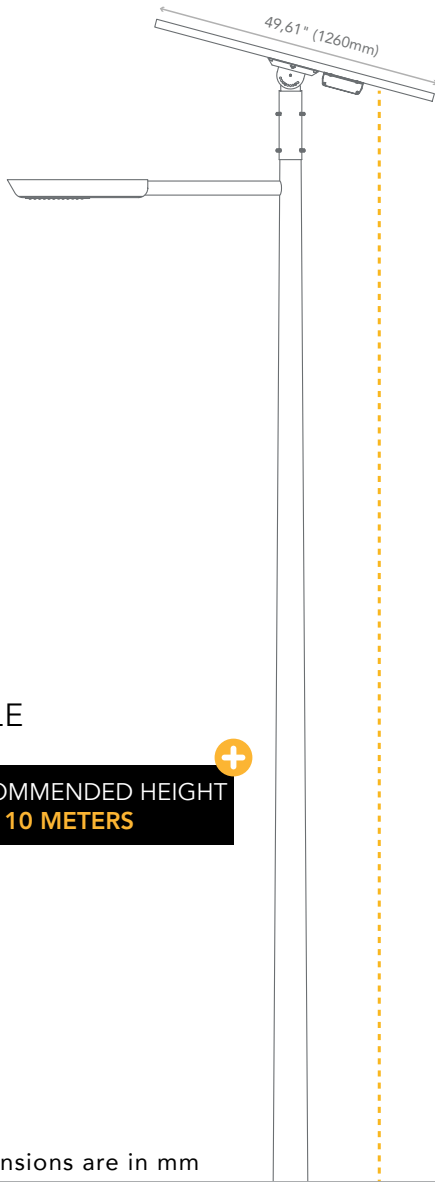

POLE

RECOMMENDED HEIGHT
8 TO 10 METERS

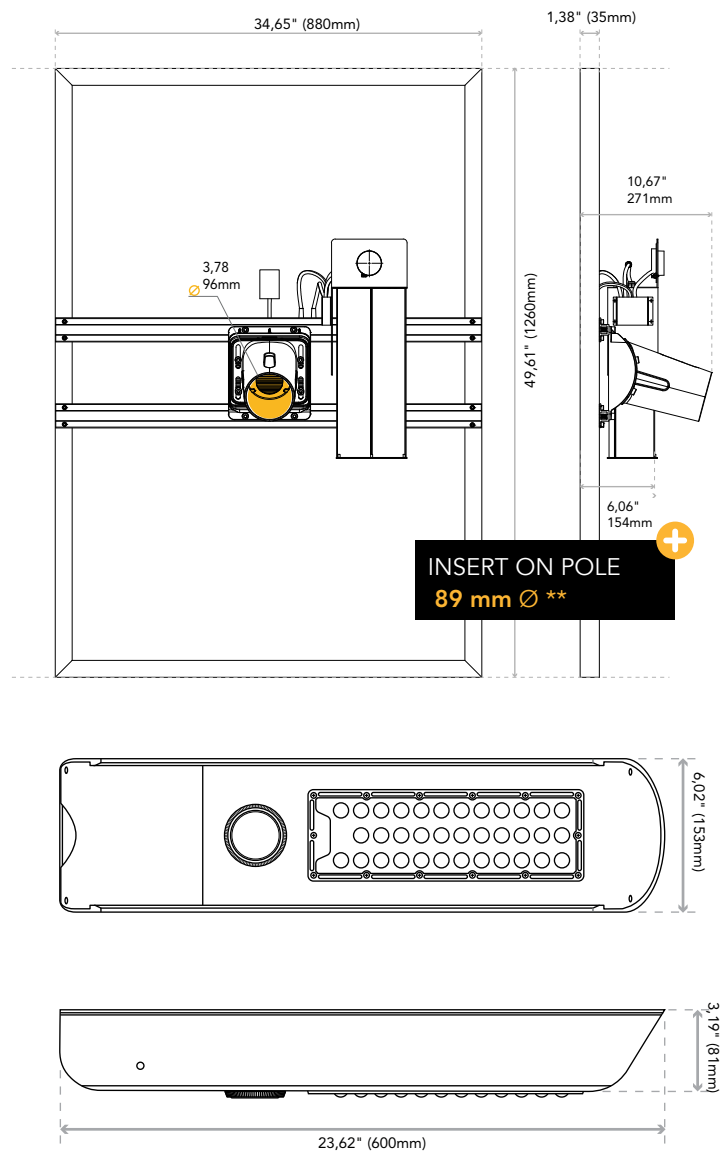

INSERT ON POLE
89 mm Ø **

*All dimensions are in mm

** Available in 76mm Ø